

Firestone

BUILDING PRODUCTS

NOBODY COVERS YOU BETTER.™



Firestone RubberGard™ EPDM Products

EXPERIENCE A PRODUCT THAT STANDS THE TEST OF TIME.



Firestone RubberGard™ EPDM

Exceptional building performance starts at the top.

With more than 35 years in EPDM roofing, Firestone Building Products has a proven track record of manufacturing products with **superior durability, flexibility** and **UV resistance**. Firestone's synthetic rubber compound is the foundation for RubberGard EPDM, the industry's premium-grade EPDM roofing membrane (available in both white and black).

From office buildings and distribution warehouses to hospitals and schools, RubberGard EPDM delivers **outstanding, long-lasting performance** in all climates worldwide.

Don't just cover your roof; guard it with Firestone's RubberGard EPDM membranes.

RUBBERGARD EPDM SYSTEM OPTIONS

Fully Adhered
RubberGard EPDM

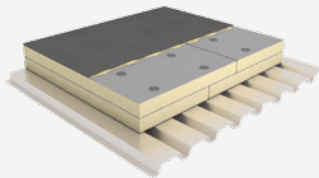

- Available in black or white
- Popular choice for new construction and re-roofing
- Ideal where ease of inspection and maintenance are important
- Can be installed on high-slope roofs (e.g., barrels and vaults)

Ballasted
RubberGard EPDM

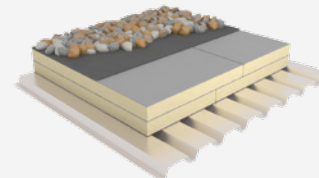

- Features large roofing panels (up to 50' x 200') covered with pavers or smooth, washed stone
- Fast coverage and economical installation
- Ideal for stores, offices and warehouses
- Aesthetically pleasing appearance

Mechanically Attached
RubberGard EPDM

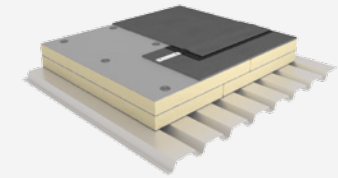

- Accommodates a wide variety of roof configurations
- Popular choice for re-roofing
- Can be designed to meet special requirements by increasing wind uplift resistance

TOP FIVE BENEFITS OF RUBBERGARD EPDM



SUPERIOR DURABILITY

- Exhibits outstanding resistance to UV radiation, ozone and weathering
- Offers excellent low-temperature properties and longer service life



RAPID AND EASY INSTALLATION

- Available in widths from 5–50' and lengths up to 200'
- Requires fewer seams and less installation time compared to other single-ply membranes



LOWEST LIFE CYCLE COST

- Little or no maintenance required
- 35+ years of proven service life of membrane = one of the lowest roof life cycle costs



HIGH FLEXIBILITY AND ELONGATION IN ANY CLIMATE

- Easily contours to unusual roof shapes
- Elongates to over 300% of original dimensions, exhibiting outstanding thermal expansion and contraction characteristics



SUSTAINABLE AND ENVIRONMENTALLY FRIENDLY

- Limited environmental impact during manufacturing and use (membrane is fully recyclable)
- Whether you choose black or white EPDM, the system's thermal performance can reduce energy consumption





RubberGard EPDM Platinum™ Systems

Designed with the industry's most durable EPDM Membrane—90 mil of uninterrupted thickness—the RubberGard EPDM Platinum System is the best roof solution out there.

IN ADDITION TO LONG-LASTING PERFORMANCE, RUBBERGARD EPDM PLATINUM MEMBRANE DELIVERS:

- UL- and FM-rated systems
- 90-mil overall thickness
- 10' wide and 16' 8" wide no-fold panels
- Available in 50' and 100' roll lengths
- More flexibility than thermoplastic membranes, allowing year-round application
- Mechanically attached, fully adhered or ballasted options
- Availability in both white and black
- Exceptional 30-year warranty coverage



FIRESTONE RED SHIELD™ PLATINUM™ WARRANTY



With RubberGard EPDM Platinum Systems, you'll enjoy the benefit of the Firestone Red Shield Platinum Warranty that includes **30-year coverage** of:

- Puncture: Coverage for incidental punctures
- Puncture/hail: Coverage for punctures of up to 2"-diameter hail
- Puncture/hail/wind: Coverage for punctures, hail and 100-mph wind



RubberGard EPDM SA with Secure Bond™ Technology

This self-adhering membrane offers a **revolutionary, factory-applied, pressure-sensitive adhesive.**

Designed to be the next generation in fully adhered roof system applications, our Secure Bond Technology ensures uniform adhesion coverage across the entire membrane, creating one of the **most powerful bonds possible.**

This advanced technology significantly improves installation speed over traditional EPDM fully adhered systems and widens the weather window, with the ability to install down to 20°F.

THE FIRST EPDM SA SYSTEM ON THE MARKET!

COLD AND HOT WEATHER PERFORMANCE

TACK TEST Firestone vs. Competitors

Loss/Gain in Adhesiveness vs. Performance @ 60° F

- Firestone Secure Bond
- Competitor 2
- Competitor 1

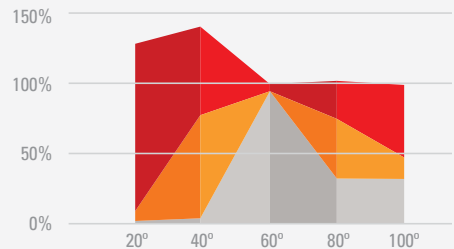

- Significantly expand your annual installation window, even down to 20° F with outstanding adhesion

INSTALLATION SPEED

ADHESIVE FLASH OFF TIMES AT VARIOUS TEMPS in minutes

	Firestone Secure Bond	Standard Bonding Adhesive	LVOC Bonding Adhesive
	0	9	14
	0	17	19
	0	19	24
	0	20	27

- Installs from two to five times faster than standard fully adhered applications, depending on ambient conditions.
- Requires no primer on approved substrates and is ideal for vertical applications.



RubberGard EPDM Pre-Taped (PT) Membranes

These membranes dramatically expand the popular RubberGard and EcoWhite product lines to include both 60-mil and 90-mil thicknesses.

Pre-taping yields the following features and benefits:

Easier and faster installation → Significantly reduces labor costs

Factory-installed seam tape → Higher-quality seams

Seam tape is cut flush with membrane → More aesthetically pleasing finished product

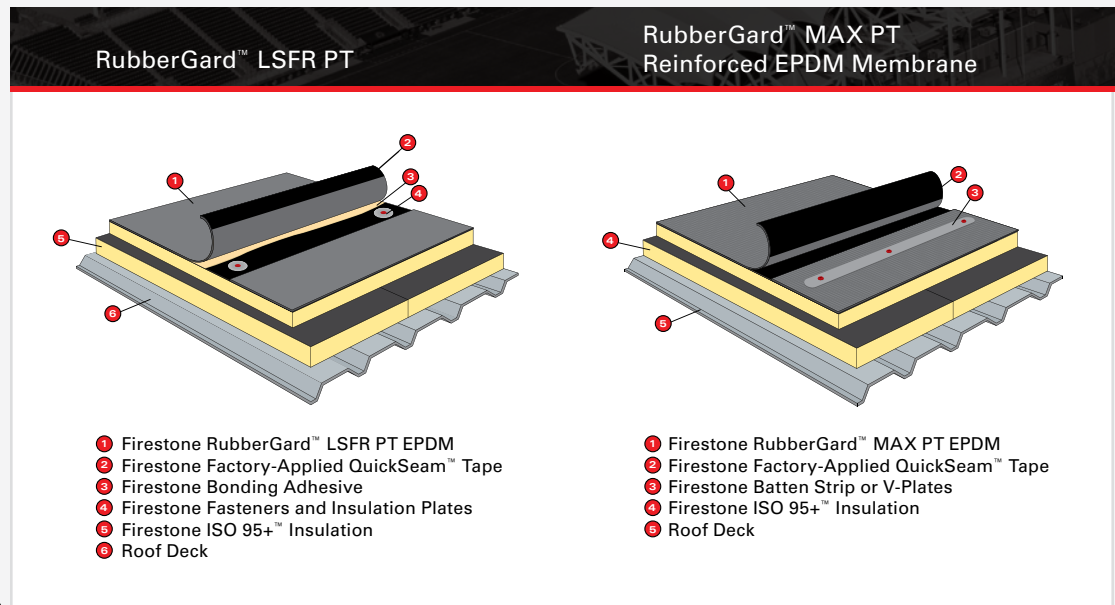

RubberGard EPDM PT membranes are available in the following options:

RUBBERGARD EPDM LSFR PT

- Available in widths up to 30 feet and thicknesses up to 90 mil
- Designed for low-slope applications
- Offers increased fire resistance

RUBBERGARD EPDM MAX PT

- Available in widths up to 10 feet and thicknesses up to 75 mil
- Excellent for roofs with frequent service demands
- Reinforced to combat tears and punctures
- Provides superior resistance to wind forces

RUBBERGARD ECOWHITE EPDM PT

- Available in widths up to 25 feet and thicknesses up to 90 mil
- Outstanding solar reflectivity and durability
- Membrane is eligible for a Red Shield Platinum Warranty up to 30 years
- Seam tape is cut flush with membrane for a more aesthetically pleasing, finished roof

Other EPDM membrane options:

RUBBERGARD MAX EPDM (REINFORCED) MEMBRANE

Available in 45-, 60- and 75-mil

RubberGard MAX (reinforced) EPDM is an internally reinforced, cured, single-ply roofing membrane that is designed to combat roof tears and punctures, and provides superior resistance to wind forces. If you are looking for added strength to what is already the longest-lasting roofing system, RubberGard MAX is your choice!

ULTRABLEND™ ROOFING SYSTEM

We've combined EcoWhite EPDM membrane with UltraPly™ TPO membrane to create a better single solution for both horizontal and vertical roofing needs. The UltraBlend System offers faster installation and lower installation costs.

Use EcoWhite EPDM membrane and accessories for vertical surfaces such as parapets, walls, curbs and penetration details, and UltraPly TPO membrane for horizontal roof surfaces.

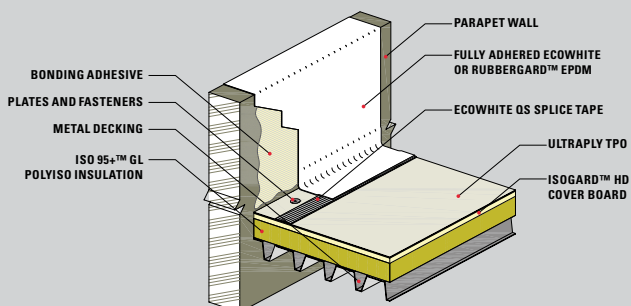

METAL ROOF RETROFIT

A cost-effective solution

This cost-effective solution provides many benefits, including:

- Highly reflective membrane options (EcoWhite EPDM and UltraPly TPO)
- Improved energy efficiency through the addition of insulation
- Extends the life of an existing roof for 20 years or longer when installed over a worn metal roof



RubberGard EcoWhite™ EPDM

Keep rooftops cooler while maintaining the high standards you have come to expect from Firestone. RubberGard EcoWhite EPDM membrane combines the proven performance of EPDM with a highly reflective white surface for regions that have higher cooling costs.

RubberGard EcoWhite EPDM is **easy to handle, installs quickly** and **is more flexible** than thermoplastic single-ply membranes, making it ideal for year-round applications.

ENJOY THE FOLLOWING BENEFITS WITH ECOWHITE:

- The highest CRRC aged solar reflectance rating for white EPDM—measured at 0.72 vs. the competitive product at 0.64
- Qualifies for the ENERGY STAR® Program
- Contributes to USGBC LEED® certification
- Assists in RoofPoint certification
- Can provide significant energy savings
- Available in both 60- and 90-mil





QuickSeam™ Accessories

TAPE

The QuickSeam Tape System is the most advanced method of field seaming EPDM membrane. Contractors appreciate that QuickSeam Tape can be **applied faster** than other seaming methods, while specifiers recognize the **performance, environmental** and **quality control** advantages. Plus, QuickSeam Tape is compatible with all RubberGard EPDM roofing membranes.

In UL-observed tests, QuickSeam Tape products exhibited **twice the seam strength** of conventional splice adhesive.

SA FLASHING

QuickSeam SA Flashing consists of an 18-inch wide, 60-mil RubberGard EPDM membrane laminated to QuickSeam Tape. The self-adhering technology of Quickseam SA Flashing was developed for both curbs and parapets in association with RubberGard EPDM roofing systems.

QUICKSEAM PRODUCTS HAVE BEEN SUCCESSFUL OVER THE YEARS DUE TO THEIR MANY BENEFITS, INCLUDING:

- Easier and faster installation, which can significantly reduce labor costs
- Factory-installed tape that yields higher quality seams
- Reduction of VOCs on the job site
- Tested and proven quality and reliability

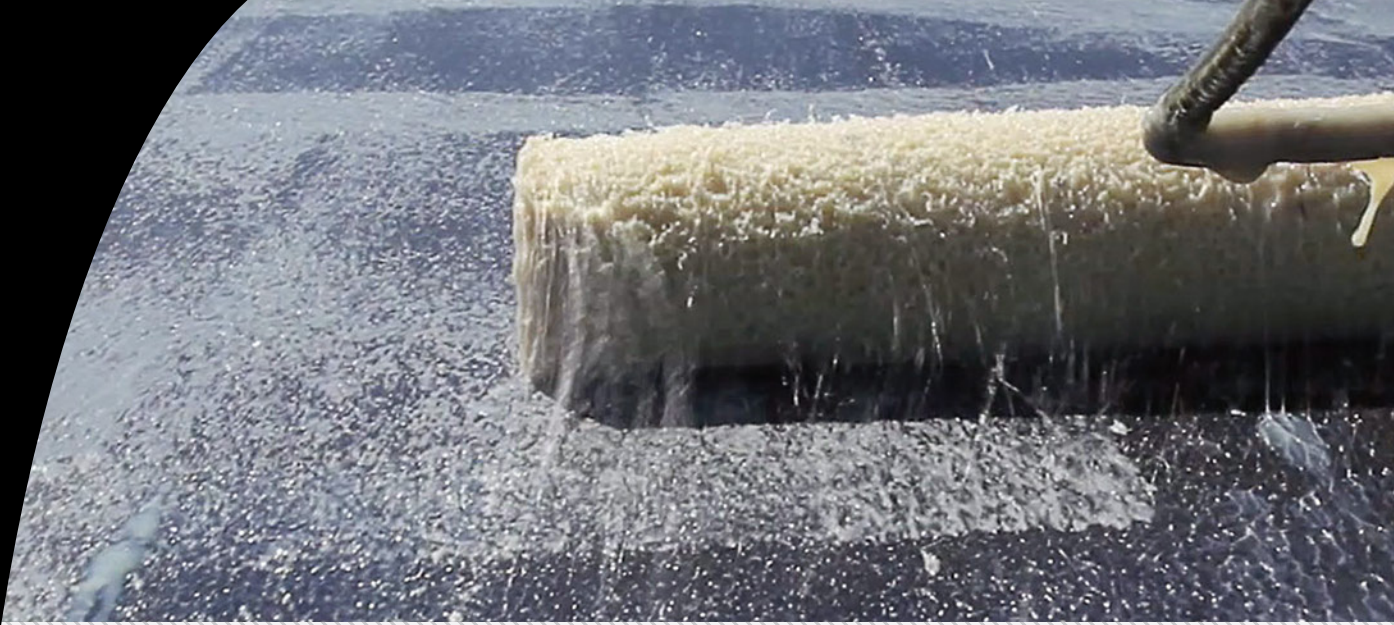

Primer

SINGLE-PLY LVOC PRIMER

Long-Term Bond Strength Solution

When it is time to prepare your membrane for seam tape, use Firestone's Single-Ply LVOC Primer. This solvent-based primer is designed to clean and prepare either RubberGard EPDM or UltraPly TPO membranes to receive QuickSeam Tape products.

It has been extensively tested and proven to provide **superior adhesion** while complying with current VOC regulations. Its formula ensures **excellent initial** and **long-term bond strength** while **flashing off much more quickly** than the QuickPrime LVOC Primer (and a major competitor's LVOC primer), especially in cold temperatures.



Adhesives

EPDM SOLVENT-FREE BONDING ADHESIVE

Do More with Less

As air quality regulations become more stringent, you can count on Firestone for a premier solution. Our RubberGard EPDM Solvent-Free Bonding Adhesive is a synthetic, polymer-based bonding adhesive, making it nonhazardous and easy to store and ship.

- Odorless and contains near-zero VOCs
- Environmentally friendly and easy to use on occupied buildings
- Can be applied to the substrate only, cutting application time in half
- Increased coverage rate allows for up to 750 sq. ft. of coverage per pail

Use this premium product when project conditions have tighter constraints for manpower, logistics or regulations.



SINGLE-PLY LVOC BONDING ADHESIVE

Excellent, Code-Compliant Adhesion

When cold weather arrives, this is your ideal bonding adhesive for adhering membranes in VOC-regulated areas.

- Compatible with EPDM and TPO membranes
- Compliant with the Ozone Transport Commission's (OTC) regulations
- Formulated to mix, pour and apply smoothly for easy application

This solvent-based formulation can be applied as low as 20°F and dries up to seven minutes faster than a major competitor, making it a **great cold weather product**.



EPDM BONDING ADHESIVE BA-2004(T)

History of Proven Performance

This solvent-based contact adhesive is designed specifically for bonding Firestone RubberGard EPDM membranes and flashings to approved substrates—and has a long-standing history of success. It is formulated with a wide application window, making it easy to install. If the job is exempt from VOC regulations, this is your cost-effective solution for adhering RubberGard EPDM membranes.



Firestone
BUILDING PRODUCTS
NOBODY COVERS YOU BETTER.™



Partnering with Firestone Building Products means superior support that goes beyond the materials you need for your projects. We look at the big picture with you, taking the entire building envelope into consideration, so we can provide you with a complete solution. For exceptionally performing building materials backed by the services, warranty and expertise you need, count on Firestone. Because...

NOBODY COVERS YOU BETTER™



For more information, ask your local Firestone
Sales Rep or visit FIRESTONEBPCO.COM.

FIRESTONE BUILDING PRODUCTS
250 WEST 96TH ST., INDIANAPOLIS, IN 46260
CORPORATE OFFICE: (800) 428-4442 • (317) 575-7000

 /FirestoneBuildingProducts  @FirestoneBPCo

Note: This brochure is meant only to highlight Firestone's products and specifications. Information is subject to change without notice. ALL products and specifications are listed in approximate weights and measurements. For complete product and detail information, please refer to the Technical Manual. Firestone takes responsibility for furnishing quality materials which meet Firestone's published product specifications. As neither Firestone itself nor its representatives practice architecture, Firestone offers no opinion on, and expressly disclaims any responsibility for, the soundness of any structure on which its products may be applied. If questions arise as to the soundness of a structure or its ability to support a planned installation properly, the owner should obtain opinions of competent structural engineers before proceeding. Firestone accepts no liability for any structural failure or for resultant damages, and no Firestone representative is authorized to vary this disclaimer.



Printed on
Recycled Paper